

D-Link[®]



D-Link[®]

Annual Report 2007

connecting people's lives, wired and wireless



"D-Link's core competency is in Ethernet networking, and the Company drives innovation and development by producing a wide range of powerful high-end wired and wireless networking solutions for home and businesses at the enterprise, workgroup and departmental processing levels."

– Ken Kao

In Memoriam



Ken Kao
Chairman and CEO
D-Link Group
1950-2008

Financial Highlights

(U.S. Dollars in Thousands)	2007	2006 (US\$)	% Change	2005	2004	2003
Net Sales	\$1,103,283	\$1,280,619	-13.8%	\$1,131,954	\$966,584	\$728,062
Operating Income	\$82,117	\$117,519	-30.1%	\$79,241	\$78,592	\$46,655
Income Before Tax	\$115,334	\$114,910	0.4%	\$70,885	\$96,381	\$45,246
Net Income	\$101,680	\$77,473	31.2%	\$50,897	\$77,966	\$39,992

- 2007's figures deconsolidated ODM/OEM business from Alpha Networks.
- If looking at brand business comparison, 2007's Net Sales, Gross Profit, and Operating Income grew 11.2%, 15.7%, and 1.1%, respectively.

* Amounts are in U.S. Dollars solely for the reader's convenience, at the rate of:
 NT\$32.88=US\$1. The average annual exchange rate for 2007
 NT\$32.53=US\$1. The average annual exchange rate for 2006
 NT\$32.14=US\$1. The average annual exchange rate for 2005
 NT\$33.36=US\$1. The average annual exchange rate for 2004
 NT\$34.36=US\$1. The average annual exchange rate for 2003

(U.S. Dollars in Thousands)	2007	2006 (US\$)	% Change	2005	2004	2003
Cash & Cash Equivalents	\$142,255	\$187,213	-24.0%	\$67,922	\$120,515	\$90,620
Total Assets	\$854,568	\$928,519	-8.0%	\$734,822	\$814,977	\$700,592
Working Capital	\$192,004	\$276,617	-30.6%	\$256,011	\$231,611	\$169,995
Shareholder's Equity	\$476,020	\$449,920	5.8%	\$368,623	\$367,315	\$298,952
Shares Outstanding **	547,076	663,378	-17.5%	597,162	535,521	\$501,777

- 2007's figures deconsolidated ODM/OEM business from Alpha Networks.

** in Thousands

Amounts are in U.S. Dollars solely for the reader's convenience, at the rate of:
 NT\$32.52=US\$1. The prevailing rate on December 31, 2007
 NT\$32.59=US\$1. The prevailing rate on December 31, 2006
 NT\$32.85=US\$1. The prevailing rate on December 31, 2005
 NT\$31.75=US\$1. The prevailing rate on December 31, 2004
 NT\$33.93=US\$1. The prevailing rate on December 31, 2003

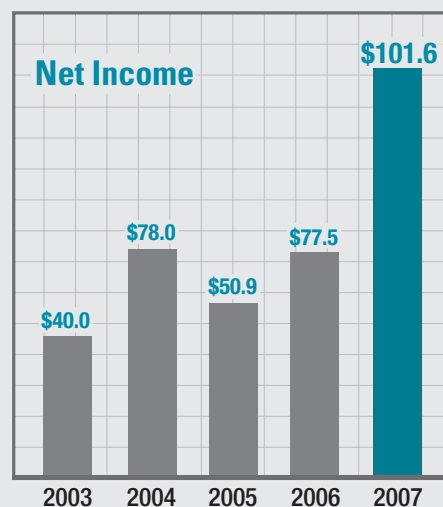
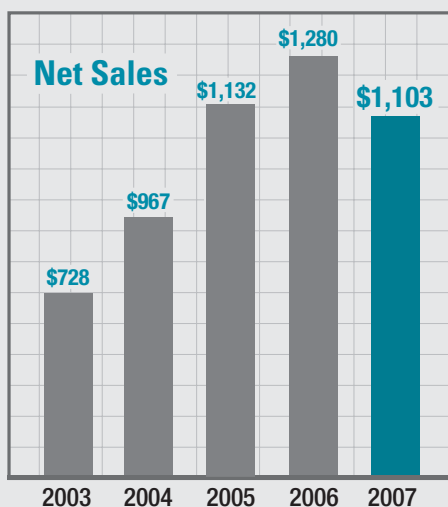

Avg. 2007 FX rate: 1 US Dollar = \$32.882 Taiwan



Letter to Shareholders, Customers, Partners and Employees

John Lee
Chairman
D-Link Group

As we embark on a new and exciting journey into FY2008, let us first take a moment to honor and pay tribute to my predecessor, the late Mr. Ken Kao.

His vision and determined guidance of D-Link, from its founding in 1986 to its undisputed leadership position of today, leaves a large void that more than humbles me to fill. With his legacy in mind, we are committed towards continuing D-Link's success and building upon it.

In FY2007, D-Link increased its revenues, developing the same trend for this year. Our aggressive push into lucrative budding markets has proven fruitful as we continue to strengthen our leading market position in Russia, Latin America, the Middle East, and Southeast Asia with a YoY growth rate surpassing 25%.

According to industry analyst In-Stat, D-Link in FY2007 remained the global connectivity leader in the small and medium sized business (SMB), small office-home office (SOHO) and consumer segments, commanding 24.4% of global market share.

In-Stat also reported that in FY2007, D-Link led in global market share for 802.11n shipments. Our initiative in bringing 802.11n to market for consumers and business has been rewarded as those markets continue to grow.

Corresponding to our corporate social responsibility (CSR) policy, FY2007 also saw the launch of D-Link Green Ethernet after years of product development efforts. We were the first networking company to introduce networking hardware designed to save energy at affordable, competitive price points without sacrificing performance.

D-Link showed tremendous foresight into consumer needs with the launch of shared network storage solutions. The home network storage market has more than doubled in the last two years. By 2009,

the 500GB and above segment will see significant demand where enclosure-only products will be particularly strong.

Reflecting on Mr. Kao's legacy and vision, we remain highly optimistic that D-Link will continue to be the world's leading networking company in FY2008 and beyond, offering highly innovative, cost-efficient solutions for both business applications and for the digital home.

Our FY2007 report no longer includes Alpha Network's ODM/OEM financials, yet D-Link once again reached the annual revenue milestone of \$1 billion (USD). While consumer expenditures in North America remained slow in 2007, we reorganized our retail and SMB channels to increase our emphasis on wireless 802.11n Wi-Fi networking, smart switches and storage products to cope with the economic challenges. In Europe, we avoided low-margin ADSL projects and focused our image as a value player by engaging in more switch, wireless 11n, and IAD (triple-play) business. In the lucrative emerging markets, we continued to gain market share from our competitors, especially with switch products.

Financial Highlights

Maintaining our healthy financial track record, we saw revenue and gross profit grow approximately 11.2% and 15.7%, respectively for FY2007. Operating profit amounted to NT\$2.3 billion, a 1.1% increase from the previous year, and net profit margin increased from 8.4% to 10%, or up 32% in absolute dollar value mainly due to the capital gain from disposal of Alpha Network shares. Annual EPS went up by 32%, increasing from NT\$4.61 to NT\$6.10 based on the 2007 year-end capital of NT\$5.471 million.

The operational strength becomes clearer when we look at the breakdown of annual revenue by region, where the Emerging and Asia Pacific markets generated 48% of total revenue, followed by Europe with 29%, then North America at 23%. Emerging and Asia Pacific markets also displayed strong sales growth with 23%, followed by a 15% increase in Europe, while North America declined 11% from FY2006.

Worldwide, we experienced increased revenue growth with WLAN leading the product categories at 39%, followed by switch at 26%, broadband at 20%, and digital home devices at 11% of global annual revenue. All had great performance, with growth rates of 14%, 14%, 9% and 5%, respectively. Switch and wireless product revenue also increased compared to the previous year, a reflection of D-Link's success in the SMB and 11n product categories.

Localized Global Presence

Our continued market penetration worldwide was due, in large part, to our strengthening of localized business units on every major continent. This is in direct correlation to our increased revenue and profit, especially in Emerging and Asia Pacific markets where 22 operating business units were added in FY2007, bringing our total global presence to 127 offices worldwide.

The strong growth momentum established in FY2006 continued into FY2007, fueled by local long-term infrastructure and economic expansion.

Emerging and Asia Pacific Markets

Switch products, especially those with Green Ethernet technology, accounted for a majority of sales in Russia for FY2007, while broadband products and IP surveillance cameras were the main cause of Latin America's growth. We successfully penetrated Japan's market in FY2007 with initial success attributed to the demand for core-to-edge managed gigabit switches, while Southeast Asia focused on wireless switch solutions. One of the reasons for our success was our ability to partner with the region's governments, universities, hospitals and other growing businesses and organizations, as well as further cultivation of new and existing channel partnerships.

Europe

The same partnership strategy was evident in all European regions. Growth in areas such as Western and Nordic Europe was stimulated by our Wi-Fi networking and IP storage product sales, while Eastern Europe saw sales steadily increase from a variety of broadband projects. We have realized the financial benefits of our efforts during the past two years from consolidating sales, marketing, and product strategies across all countries in the region, and unifying our brand presence despite the challenges of intensified competition in a mature European market.

North America

North America market revenue declined to 23% of total sales for the Company. However, we remain confident in our strategy to deal with increased price competition, high retail overheads and other challenges that face the saturated consumer market. We have increased the focus on our 802.11n solutions with aggressive pricing and product segmentation strategies to meet the growing demands for this important market segment. In-Stat reports that the North American home network storage market will continue to present the greatest opportunities worldwide in terms of volume. Media serving features that offer a simple-to-use interface is what the market wants, which D-Link provides. For the SMB and enterprise side, we are even more optimistic. Our business products are becoming increasingly attractive to organizations through our affordability, functionality and cost-effectiveness versus that of our largest competitors, especially in a downward-trending market.

The Future Remains Bright

For FY2008's industry outlook, the demand from Telcos/ISPs for networking infrastructure remains healthy. As for the enterprise sector, corporate spending seems to have softened while consumer expenditures remains stagnant, especially in developed countries. Although we see 11n Wi-Fi technology will gradually replace 11g, the future of WiMAX remains to be seen. Overall, the networking industry is projected to grow at a stable pace for FY2008.

Although D-Link saw a decline in sales among both North American and European markets, the Company believes that this is a result of the enduring economic challenges of these regions rather than a decline in global presence. Overall, profits have steadily increased, which can be accounted for by the large success in sales from both Emerging and Asia Pacific markets. D-Link continues to foresee a profitable outcome for the Company, with the North American and European regions enhancing the SMB channel coverage.

The key drivers to D-Link's growth will be the launch of new models on SMB products, such as managed Green Ethernet and Metro Ethernet switches; consumer products, such as 11n-enabled IP cameras and NAS storage, and D-Link 2.0 (D-Life) products, including IP telephony and camera devices.

Our continued growth and track record for success give us a solid foundation on which to build for the future. More importantly, it is you – our devoted employees, our loyal customers, our dedicated partners and our trusting shareholders – who we thank the most. We are proud to have you on our winning team.

Sincerely,



John Lee
Chairman
D-Link Group

Global Branding

Meeting the World's Needs through Local Units

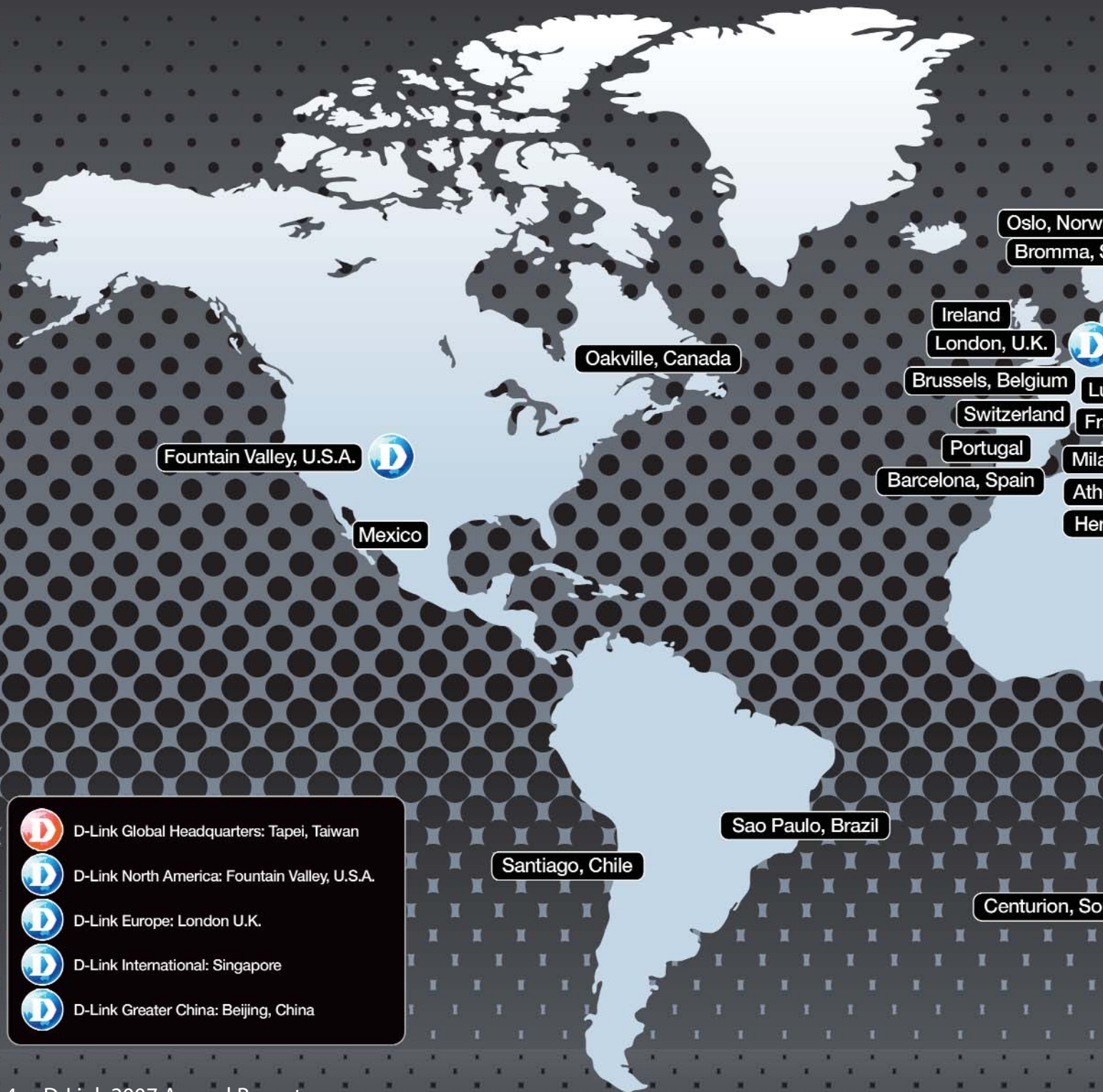

Local market understanding; International resources

Unity; a strategy for success executed on a global scale. D-Link is the worldwide leader and an award-winning designer, developer, and manufacturer of Wi-Fi and Ethernet networking, broadband, multimedia, voice and data communications and digital electronics solutions. D-Link has systematically expanded its market share by penetrating geographic targets through a strategy of establishing local business units supported by a strong corporate foundation.

Confident in the resources of D-Link headquarters to develop and deliver state-of-the-art networking products, each local business unit – regardless of its location around the world – attacks its market aggressively. The Company's innovative technology products provide solutions for home and business, built with standards-based reliability. D-Link has become a trusted international brand that connects people to their lives, their work, and to each other.



Emerging and Asia Pacific Markets

D-Link's Emerging Markets and APAC have enjoyed tremendous success over the last few years culminating in a remarkable fiscal 2007. Emerging and Asia Pacific Markets now constitute 48% of total revenue, and year over year sales growth reached 23%.

Successful areas of emphasis include aggressively pursuing Emerging Markets and strengthening D-Link's leading market positions in Russia, Latin America, the Middle East, and Southeast Asia where there has been at least a 25% growth rate, year over year. D-Link's continued focus on local business units has correlated with increased revenue and profits, especially in Emerging and Asia Pacific Markets.

Russia as a market continues to demonstrate extreme growth potential. This year, a majority of sales was attributed to switching products, particularly Green Ethernet switches. D-Link's leadership in providing green technologies reinforces the Company's goal of being a responsible corporate citizen and of pursuing and developing technology's latest trends.

Due to the growing worldwide demand for products related to ADSL, 3G, WLAN, WiMAX, VoIP and IPTV, D-Link has enjoyed increased demand for their high-performance switching and network solutions, as well as the Company's communications hardware, to support broadband providers. D-Link Latin America's growth in 2007 was due primarily to an increase in the demand for broadband products and IP surveillance cameras. iSuppli Corporation, a market-research firm, believes this rise in IP surveillance sales globally is due to rising security needs combined with technological

innovations. According to iSuppli, revenue in this segment is expected to grow to \$9 billion dollars by 2011, while maintaining a Compound Annual Growth Rate of 13.2%.

D-Link Japan's growth was due primarily to an increased demand for core-to-edge managed switch solutions, while Southeast Asia sought wireless switch solutions. These products prove that Emerging and Asia Pacific Markets are continuously upgrading their technological infrastructure and are seeking highly reliable solutions for networking needs. As these markets are further explored, D-Link will find increased demand for its exemplary solutions.

D-Link's ability to create strong partnerships between governments, universities, hospitals and other growing businesses and organizations continues to add profitability. These strategic partnerships allow D-Link to work closely with the same individuals to provide solutions that are client-specific. In this year alone, D-Link has opened 22 new operating business units, which will further allow D-Link to diversify and reap region-specific benefits. As more local business units are opened throughout the world, D-Link's already major presence on the global networking stage will become even more prevalent and decisive.



D-Link's continued focus on local business units has correlated with increased revenue and profits, especially in APAC and the Emerging Markets.

D-Link Japan's growth was due primarily to an increased demand for core-to-edge managed switch solutions, while Southeast Asia sought wireless switch solutions.



Case Study—Putrajaya Perdana Berhad

Putrajaya Perdana is Malaysia's leading construction and property development company. Their goal was to move away from labor-intensive activities through the implementation of new technologies.

Customer requirement:

Because of problems with their previous CCTV monitoring security system, Putrajaya Perdana wished to transition from coaxial-based solutions to a more satisfactory monitoring system that would be more reliable and would also function under the dynamic conditions of the construction sites.

Equipment used:

- DCS-6620 (Pan/Tilt/Zoom Network Cameras)
- DCS-3420 (Wireless Day & Night Internet Cameras)
- DWL-3200AP (802.11g Managed Access Point)
- ANT24-0800/0801/1500 (Wi-Fi Antennas)
- DGS-1005D (5-Port Gigabit Desktop Switch)

Selected features:

- IP Camera surveillance system
- Wireless connection to link back to central office
- Stronger antenna for longer distance transmission
- Switch to build the core network

Key Benefit:

D-Link Malaysia and experienced SI partner Mangué Hub presented a strong proposal of D-Link's solution. D-Link integrated wireless surveillance solution resolves the client's main concerns: Able to deliver and setup the solution in 2 weeks; Good price for new proposed solution to fit tighter budget resulting from failed legacy systems; SI is able to provide software customization and tie in other components of the solution; Strong local presence, with service and support to the client for their requirements.

D-Link provided a solution which utilized IP cameras, antennas and access points that integrated seamlessly with the existing surveillance solution.

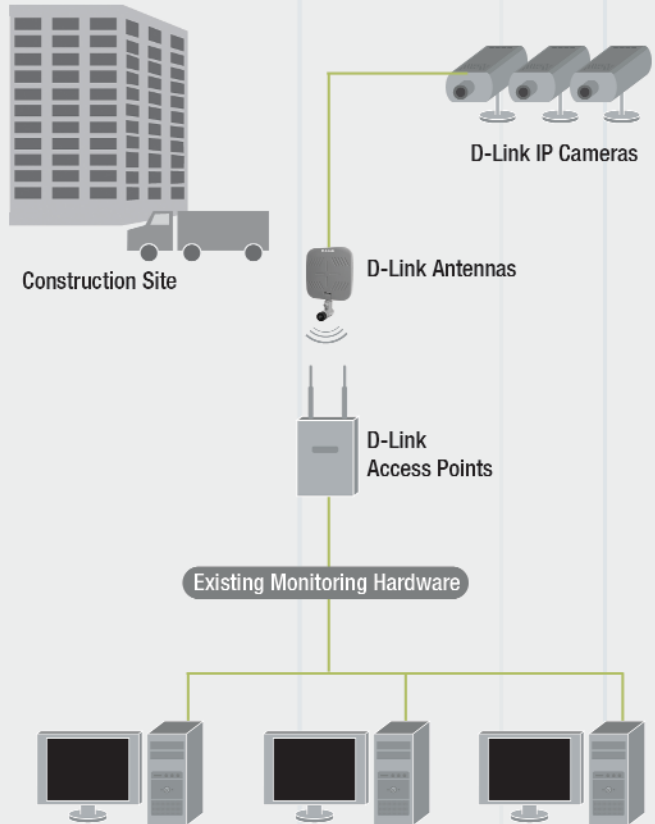

APAC Enterprise Metro Ethernet Service Revenue Forecast: 2005–2010
Source: In-Stat 07/06

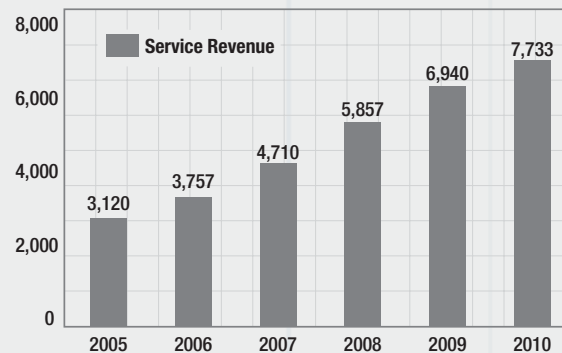

Ethernet service subscribers among APAC enterprises is forecasted to grow to over 2.648 mln by 2010, a good indicator for continued penetration of D-Link switching solutions throughout the region.

Europe

2007 was an important and successful year for D-Link Europe. In a region where many diverse cultures live side by side in a geographically compact space, D-Link Europe succeeded last year in contributing 29% to the corporation's revenues.

Managed through its London Headquarters, D-Link's European team consistently strives for growth, reliability, service and support. D-Link Europe operates on a principle of "fusing a global vision with local insights," successfully adapting pan-European strategies to local opportunities.

From a sales and marketing perspective, D-Link Europe accomplished three major milestones in 2007. The first major milestone was the launch of the new Wireless N technology, crowning D-Link as the market leader for Wireless N. Secondly, the successful launch of the industry's first "Green Ethernet" products — that have earned a myriad of accolades throughout Europe — as environmental factors grow to be increasingly important in the purchasing decision. Lastly, D-Link Europe made a sound investment into resources to strengthen its B2B business, enhancing D-Link's overall brand awareness and securing important project wins.

Further to sales and marketing efforts, D-Link's European wide logistics service delivers real efficiency and distribution performance, ensuring market-leading levels of customer service with over 98% delivery accuracy. D-Link Europe has shipped 7.7 million products from the 94,000 square foot distribution and repair center based in London, whilst carrying out 60,000 product tests and 40,000 product repairs.

Whilst the achievements of 2007 have been considerable, D-Link Europe is now dedicated to continuing its expansion

during 2008. As the mature European market proves taxing during a time of financial insecurity, D-Link Europe will ensure its attention is evenly focused on the key market segments. Building on the achievements of 2007, D-Link Europe aims to further extend its reach into the B2B sector, maintain its number 1 position in the Wireless N market where growth is still forecasted, as well as target the service provider business where Integrated Access Devices (IADs) are in demand.

Naturally, D-Link continues to uphold the green motto — within its solutions and as part of its corporate social responsibilities — with the European region being the most demanding globally in expecting an environmental conscience from all businesses.

To improve operational efficiency further, D-Link Europe is determined to minimize the various physical constraints involved in servicing the vibrant Eastern European emerging markets. Efficiency will be further improved by consolidating and streamlining the after sales service proposition for all its customers with special emphasis on the business solutions portfolio. D-Link is, in addition, committed to continuing to reduce the environmental impact of its operations throughout the supply chain, through technological as well as process re-engineering projects.

D-Link, in 2007, set out to segment its offering and now truly caters to the differing needs of its two key audiences: the business and consumer markets.

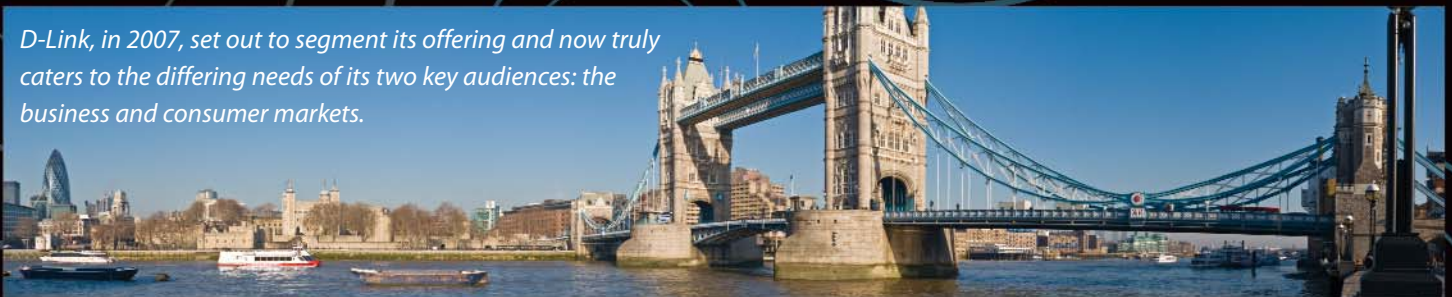



An increase in partnerships with governments, universities, hospitals and other public sector organisations helped D-Link Europe to penetrate previously untouched markets in 2007.

Case Study—Hafslund Telekom, Nittedal (Norway)

Hafslund ASA is one of the largest listed electrical utility companies in the Nordic area. Its Telecom subsidiary owns and leases a total of approximately 1,800 kilometres of fibre optic network in Oslo and the surrounding region.

Customer requirement:

Provide residential and business end-users with Gigabit broadband Internet connectivity based on a Fiber-To-The-Building (FTTB) infrastructure. Each CPE consists of a fully managed switch.

Equipment used:

- DGS-3324SR/SRi (xStack® Managed Layer 3 Gigabit Stackable Switch)
- DXS-3326GSR (xStack 26 Port Layer 3 Managed Stackable 10GB Switch)
- DES-3010G (Layer 2 Managed 8-Port 10/100Mbps Switch with 1 x 1000BaseT & 1 x SFP Port)
- DEM-310GT (1-Port mini GBIC module for 1000BaseLX (LC duplex))

Selected features:

- IP Multicast for TV, VoD and video conferencing services
- Multi-Layer ACLs and 802.1Q VLAN, for tight end-user privacy
- Bandwidth control, for guaranteed service levels

Key Benefit:

10-Gigabit stacking provides the operator with the redundancy and scalability necessary to achieve a high level of customer satisfaction.

D-Link switches make it possible to provide residential and business end-users with Gigabit broadband Internet connectivity based on a Fiber-To-The-Building (FTTB) infrastructure.

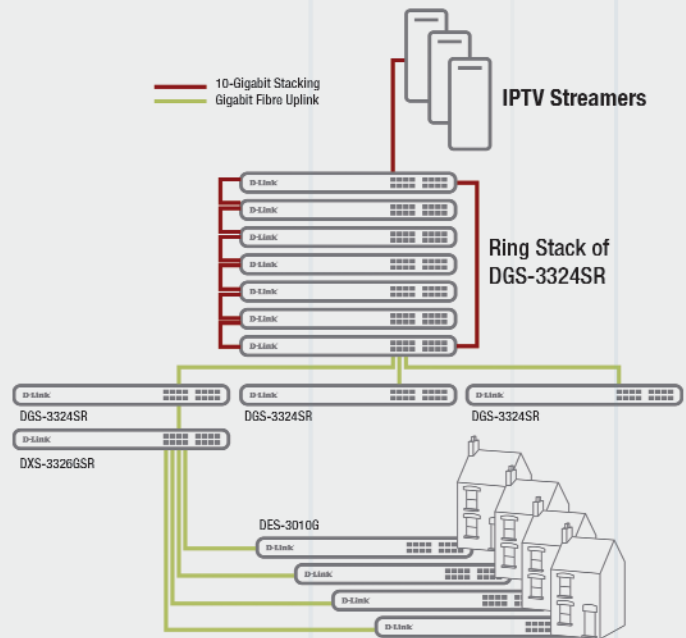

Enterprise Infrastructure Equipment

Millions (USD). Source: IDC European Enterprise Networking

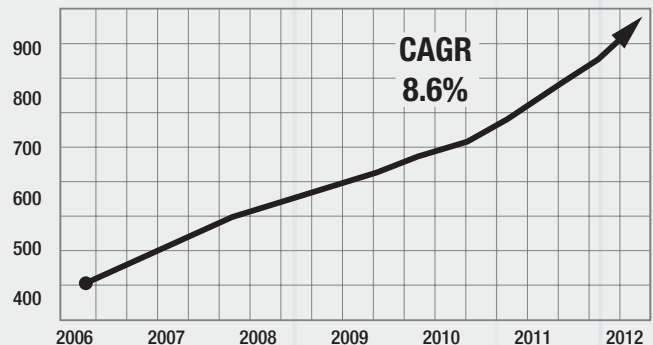

Infrastructure equipment for the enterprise market will grow at a CAGR of 8.6% in Europe from \$464 in 2006 to \$932 in 2012. D-Link switching solutions are well-positioned to fulfill this growing need.

North America

D-Link North America's business units focus on innovation and technology in both consumer and business products serving to increase profitability.

Although D-Link North America's revenue declined to 23% of total sales, the Company is pursuing aggressive programs and product diversification to generate new interest and sales.

The U.S market for business products remains strong. Many SMBs and enterprises are selecting D-Link solutions over the more costly products and services of other networking companies. Sales' focus and marketing campaigns aimed at increasing revenue in the SMB and enterprise markets helped to increase visibility of the outstanding solutions and value that D-Link has to offer a growing business. The "Time to Think D-Link" campaign focused on providing specific examples of business-class devices that provide powerful networking solutions at aggressive price points.

In addition to expanding business sales, D-Link was awarded a GSA contract, which allows the Company to better serve government agencies. This contract permits all federal government users to easily access D-Link's TAA-compliant, fully managed business-class stackable switches. This contract further developed the ongoing strategy of increasing channel and product expansion.

Smart switching is the fastest growing category in business-class switching. D-Link continues to strengthen and promote its Web Smart™ line, and further reinforce its position in the North American business market.

Internet surveillance is a hot topic among consumers and business customers. D-Link remains active in building out its network camera line with a focus on gaining market share in this growing segment.

D-Link has been aggressive in the development of 802.11n products for home and business. These efforts have laid the groundwork for the Company to be a leading vendor in this category. Wi-Fi N is projected to take over as the leading WLAN technology by 2010. By the end of 2007, it had already commanded 32% of overall Wi-Fi revenue, according to NPD.*

Further within the consumer and SOHO realm, D-Link has embraced technology to aid energy saving among households. D-Link Green Ethernet switches decrease energy costs by reducing power consumption without hindering performance. These switches are also among the many products that have received certification from Energy Star for the use of energy-efficient power adapters. These products provide increased peace of mind to the environmentally conscious consumer.

In addition, D-Link has been aggressive in the consumer network storage market. By the end of 2007, the Company took the lead in market share, according to NPD. D-Link also plans to enter the budding photo frame market with a Wi-Fi connected device capable of accessing Internet content.

*NPD Group is a leading global provider of consumer and retail market research information for a wide range of industries.



Many SMBs and Enterprises are selecting D-Link solutions over the more costly products and services of other networking companies..

Aggressive programs have increased the visibility of D-Link's robust business solutions and have garnered new business from a variety of customers.



Case Study – Beau Rivage Resort and Casino

The Beau Rivage Resort & Casino in Biloxi, Mississippi is one of the biggest business and gaming destinations in North America. The original resort cost \$800 million to develop, and post-Katrina renovation cost another \$550 million. Part of that renovation included plans for a state-of-the-art video surveillance infrastructure to protect guests and assets.

Customer requirement:

Beau Rivage Resort and Casino needed a highly reliable, fail-safe digital video surveillance solution that could manage massive amounts of traffic on the network and thousands of video streams for securing the casino and protecting guests.

Equipment used:

- DGS-3324SR (24-Port 10/100/1000 Switch + 4 combo SFP, 10Gig Stacking)
- DEM-310GT (1000Base-LX Mini Gigabit Interface Converter)

Selected features:

- Multicast Network Traffic and Fail-over Support to manage massive amounts of traffic
- Highly reliable and scalable for 100% uptime
- End-To-End surveillance solution

Key Benefit:

The Honeywell/D-Link video surveillance solution allows for easy expansion and is extremely reliable. Overall, Beau Rivage opted for the Honeywell/D-Link solution because of performance and reliability.

The D-Link xStack DGS-3324 switches were a perfect solution for the multicast network traffic and fail-over support required for the surveillance system.

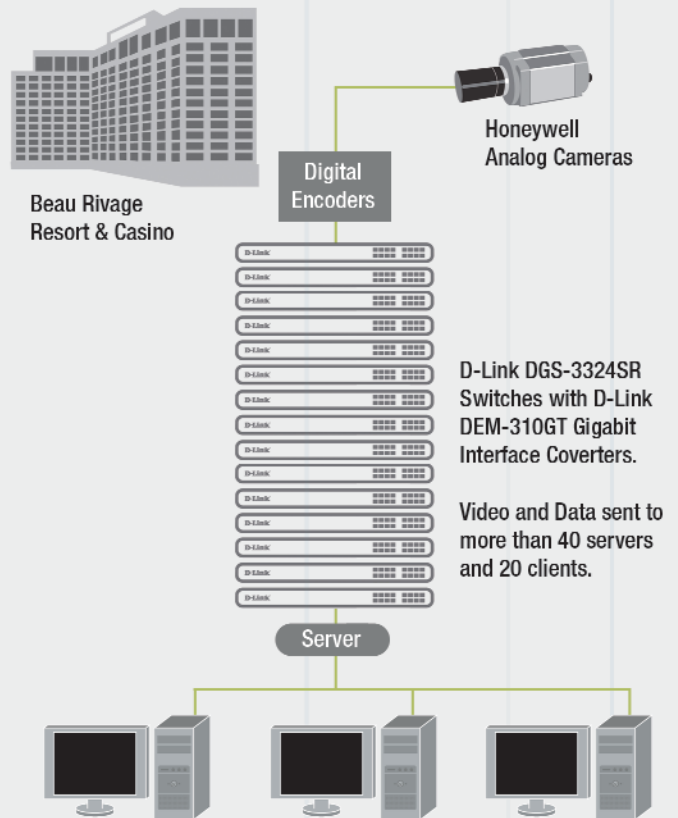

D-Link DGS-3324SR Switches with D-Link DEM-310GT Gigabit Interface Converters. Video and Data sent to more than 40 servers and 20 clients.

North American Carrier Ethernet Equipment
Billions (USD). Source: Frost & Sullivan

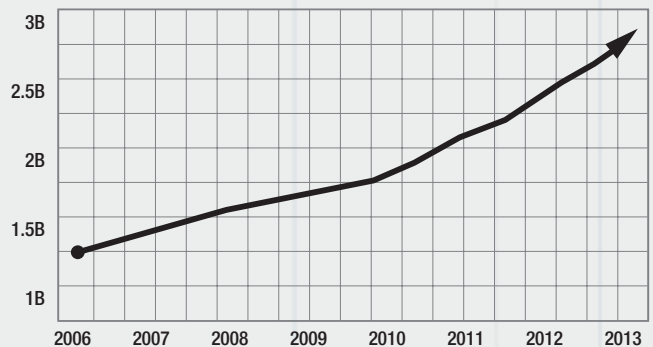

North American Carrier Ethernet Equipment Market revenue totaled \$1.45 billion in 2006, and can reach \$2.88 billion in 2013, presenting a tremendous opportunity for D-Link switching and WLAN.

Consumers & the Digital Home

The consumer demand for home networking continues to grow at an impressive rate. Leichtman Research reports that U.S. home broadband penetration reached 56% in 2007. 42% of households used broadband to access the Internet in Europe according to EUROSTAT.

As encouraging as the adoption of high-speed Internet in the home is worldwide, what consumers are doing with that access is truly exciting and illustrates the foresight of D-Link in developing products for the digital home.

“Home networking is migrating beyond its PC-centric beginnings to incorporate a variety of entertainment-oriented consumer-electronics devices. Shipments of these network-equipped devices, along with consumer PCs and home network bridges and gateways, are expected to rise to 732.9 mln units by 2011, more than triple the 225.3 mln that were shipped in 2006,” according to iSuppli.

D-Link’s innovations in the digital home, in hindsight, reflect the Company’s ability to pragmatically analyze consumer trends and provide the right products at the right time.

D-Link was first to market with 802.11n and the first to incorporate the IEEE Draft 2.0 standard. D-Link offers a good, better, best Wi-Fi N selection to consumers at great price points, along with industry leading selectable and concurrent dual band routers.

D-Link has offered network attached storage devices for a number of years. In 2007 the DNS-323 2-Bay Network Storage Enclosure became recognized for its flexibility and feature-rich

design. As an enclosure, the device allows consumers to choose the amount of capacity they need, accepting hard disks of any capacity easily formatted for RAID functionality or in a JBOD configuration. The network storage enclosure can serve media files to a wide range of connected devices in the home, making it an important piece to any home or small office network.

Interest in Internet cameras grows as consumers continue to better understand their application. D-Link Internet cameras offer such features as low-light capability, remote control of zoom, pan and tilt and even audio capture. Internet cameras plug directly into an Ethernet network or provide the same functionality through Wi-Fi, allowing them to be placed almost anywhere. D-Link’s software makes it easy to set up and manage one or multiple cameras and view them from anywhere over the Internet.

When consumers need additional wired ports, D-Link’s Green Ethernet switches are the practical and responsible choice. They implement special power-saving features that detect link status and cable length and adjust power usage accordingly.

D-Link is a pioneer in the development of media players. D-Link’s MediaLounge® line continues to make it easier for consumers to stream additional Internet media from their PCs to their TVs and home entertainment centers. In 2007, D-Link



D-Link’s innovations in the digital home reflect the Company’s ability to pragmatically analyze consumer trends and provide the right products at the right time

D-Link offers a good, better, best 802.11n Wi-Fi selection to consumers at great price points.



added Active-TV ONLINE software to the popular MediaLounge DSM-520 High-Definition Media Player, making thousands of videos accessible directly from the Internet. The Company has partnered with Microsoft to bring the Windows Media Center experience to TVs and entertainment centers with the MediaLounge DSM-750 Wireless N HD Media Center Extender.

D-Link owns the digital home and finds itself well positioned to meet this growing demand for home network functionality.

Accumulative Networked Home Devices

Source: iCumulative Networked Home Devices: International Data Corp.

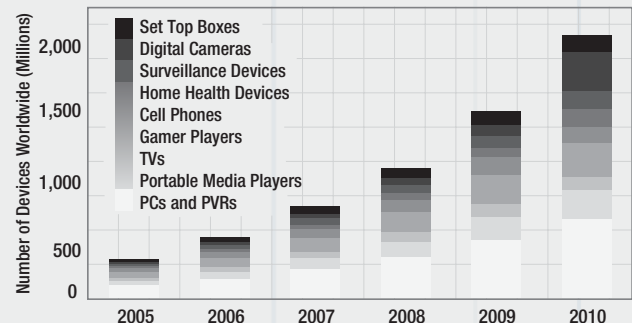

Sales of non-PC devices that can be added to a home network are projected to exceed 2 billion by 2010, including D-Link Internet cameras, storage devices and media players.

Notable Consumer Awards for 2007:



Electronic House

D-Link Xtreme N Duo MediaBridge Awarded Electronic House Magazine Product of the Year 2007



PC Magazine

D-Link Xtreme N® DIR-655 Wireless Router Wins PC Magazine Editors' Choice Award



PC DIY Magazine

D-Link 3G Mobile Router for UMTS/HSDPA Networks Wins the Editor's Choice Award from PC DIY Magazine in Taiwan

D-Link Consumer Products



Home Networking

D-Link is a dominant player in home networking with award-winning products that are powerful and easy to use.



Switching

To add additional wired ports for Ethernet connectivity to your D-Link router, simply add a Green Ethernet 5- or 8-port desktop switch.



Multimedia

D-Link MediaLounge-branded products bring new options to the consumer in the digital home by uniting PCs and devices to a home entertainment system.



Voice & IP Communications

D-Link VoIP products are sold through retail, partners and service providers, bringing affordable calling options over an Internet connection.



Home Network Storage

D-Link home storage enclosures for sharing hard drives are ideal for consumers to house their entire library of digital music, photos and data files for instant access.



Internet Cameras

D-Link SecuriCam cameras bring anytime, anywhere access to live video streams over the Internet to any PC in the world.



Cable/DSL Modems

D-Link broadband modems are standards-based connectivity solutions sold through the retail channel and service providers.



USB/Firewire

D-Link is a market leader in plug-and-play, high-bandwidth connectivity solutions for computers, peripherals, and consumer electronics products.

Business-Class Solutions

It is D-Link's strength as a true designer and manufacturer of business-class networking equipment that makes it a worldwide leader with solutions for businesses of any size.

According to Gartner, Ethernet switch port shipments will grow at a compound annual rate of 5% from 2006 to 2010, and end-user spending will continue to grow during the same period. D-Link is uniquely positioned to secure more than its share of that projected growth.

D-Link manufactures and distributes a wide range of networking solutions for businesses of all sizes and levels, including the small office home office (SOHO), small and medium sized business (SMB), large enterprise, government agencies and educational institutions.

With more and more mission critical applications running over networks today, the protection of those network-attached resources from exploitation comes to the forefront for all businesses. D-Link NetDefend Network Security provides solutions to protect networks of any size.

The D-Link xStack family is the industry's most affordable multi-layer stackable Gigabit switch solution with integrated 10-Gigabit support. The Company's unique future-proofing designs — with impressive support for 10-Gigabit Ethernet core technology — are an ideal migration path for Gigabit Ethernet and Gigabit-to-the-desktop.

As businesses scale, users expect the convergence of wired and wireless networking for the ability to roam between access points. New applications like Wi-Fi VoIP (Voice over

Internet Protocol) require the ability to roam seamlessly and securely. D-Link is at the forefront of switches and equipment for the converged network.

D-Link Web Smart switches are perfect for small and medium-sized businesses that require advanced features like SNMP, VLANs, QoS and secure authentication. Smart switches blend plug-and-play simplicity with exceptional performance and reliability to create cost-effective solutions for bandwidth-starved workgroups and departments.

D-Link's Green Ethernet switches implement special power-saving features that detect link status and cable length to adjust power usage accordingly. In a standard workday scenario where PCs are used for 10 hours a day and powered off 14 hours a day, and connected to the switch using 20 meter cables, D-Link's Green Ethernet can save up to 40%* of power used for each system.

D-Link IP Telephony communication solutions are expandable phone systems providing advanced functionality for any small business with as many as 50 extensions, in a single location or throughout a campus environment. In 2007, D-Link launched VoiceCenter™, a Microsoft Response Point phone system, adding a well-known partner to further serve small businesses.

The xStack Storage iSCSI Storage Area Networking (SAN) collection was designed to directly address the growing

*Power savings may vary depending on products used. Maximum power savings when compared to a D-Link conventional switch. Uses up to 44% less energy when connected devices are powered down.



D-Link customizes and distributes a wide range of networking solutions for businesses of all sizes and maturity.



As businesses scale, users expect the convergence of wired and wireless networking for the ability to roam between access points. D-Link is at the forefront of switches and equipment for the converged network.

requirements for storage solutions: Application Performance, Data Backup and Recovery, Server Consolidation Disaster Recovery.

D-Link AirPremier wireless components provide flexible and affordable solutions to expand existing business networks quickly and securely. D-Link is the industry pioneer in wireless networking, providing performance breakthroughs in wireless connectivity that make integration with existing wired networks seamless and cost-effective.

Application & Ethernet Switches Manufacturer Revenue Forecast
Source: Infonetics Research

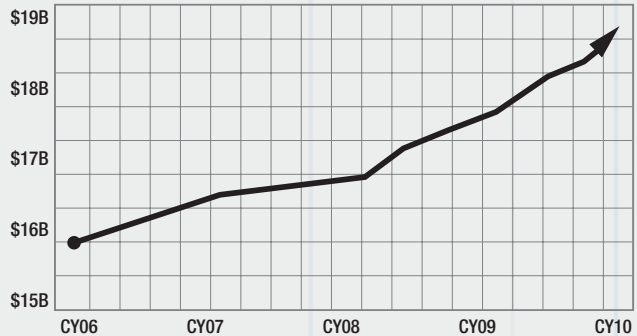

Annual worldwide fixed and chassis Ethernet switch sales are forecast to grow from \$15.9 billion to \$18.3 billion between 2006 and 2010.

Notable Business Awards for 2007:



VARBusiness

D-Link Certified as Five-Star Vendor From CMP'S VARBusiness Magazine



GovernmentVAR

D-Link Earns 5-Star Rating From CMP'S GovernmentVAR Magazine



TechTarget

D-Link Switches Win Multiple Product Leadership Awards from TechTarget

D-Link Business Products

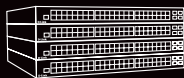

Switching

D-Link business-class Ethernet switching products bring price for performance-leading solutions to the Small to Medium and Enterprise businesses.



Network Storage

The D-Link xStack Storage® Area Network (SAN) array is designed to provide a reliable network data storage solution for customers in entry-level and SMB segments.



Enterprise Wireless

D-Link AirPremier wireless solutions are designed for medium to large businesses that require extensive feature sets for both indoor and outdoor WLAN applications.



Internet Cameras

D-Link's full-featured camera surveillance systems provide remote video and audio monitoring, recording and pan/tilt/zoom over the Internet for business.



VPNs

D-Link Virtual Private Network (VPN) products establish strong and secure connections to business headquarter networks for the remote office worker and business traveler.



KVM Switches

D-Link Keyboard, Video, Mouse (KVM) switches allow for easy management of multiple PCs or servers for the IT manager and integrator.



Firewalls

D-Link NetDefend family of products effectively protect networks, corporate resources and data communication from outside intrusion.

Broadband

With overall home broadband penetration breaking 50% in a September 2007 survey, Pew Internet found that broadband was adopted by a majority of consumers faster than other technologies.

Broadband took only 10 years to reach 50% adoption. The CD Player took 10.5 years, the VCR 14 years, cell phones took 15 years, and color TVs took 18 years, as did the personal computer. And the demand for broadband shows no signs of slowing down.

D-Link's broadband business grew 8.8% in 2007. In addition to its many products that take advantage of the speed of broadband, D-Link continues to lead the market in solutions for service providers, meeting customer demand for broadband at home, work, and on the go.

One of the key drivers in the growing demand for broadband is VoIP. Worldwide VoIP service revenue jumped 66% to \$15.8 billion in 2006 after more than doubling in 2005, and is expected to more than triple by 2010, according to Infonetics Research. Hosted VoIP services continue to outpace managed IP PBX services by far, with residential services fueling the market, but the business segment is also growing, and will continue to do so, the report says.

At the 2007 Interop tradeshow, D-Link debuted and demonstrated VoiceCenter, a feature-rich and cost effective small-business Internet Protocol (IP) phone system, designed for ease of use and manageability. Ideally suited for the small business requiring up to 50 extensions, D-Link VoiceCenter together with Microsoft Response Point software supports both Voice over IP and traditional phone lines. D-Link

VoiceCenter offers all of the essential telephony features required for small businesses, including sought-after voice recognition and built-in Auto Provisioning configuration capabilities.

D-Link modems are standards-based connectivity devices that deliver strong, high-speed Internet connectivity. D-Link modems support both cable and DSL connections, as well as integrated access devices that house a high-performance cable or DSL modem and multi-port wireless router in one unit. D-Link remains on the crest of emerging technologies with its WiMAX routers, used by service providers as a "last-mile" solution to economically deliver broadband to homes where hardwiring is cost-prohibitive due to geographic challenges.

D-Link's worldwide reputation for dependable broadband solutions helps to fuel the Company's continuing market penetration. Quality broadband solutions are offered at a real value to service providers in both Developed and Emerging Markets. The tremendous global growth of broadband demonstrates the importance of D-Link's leadership in this technology.

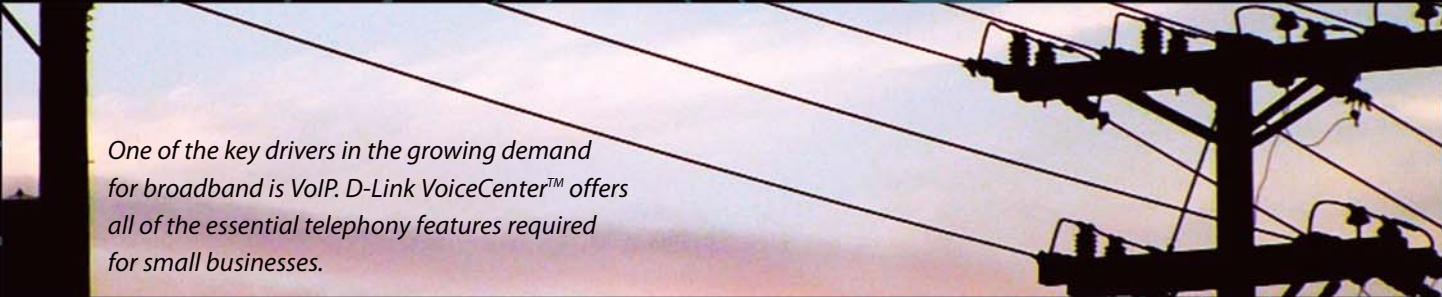

One of the key drivers in the growing demand for broadband is VoIP. D-Link VoiceCenter™ offers all of the essential telephony features required for small businesses.

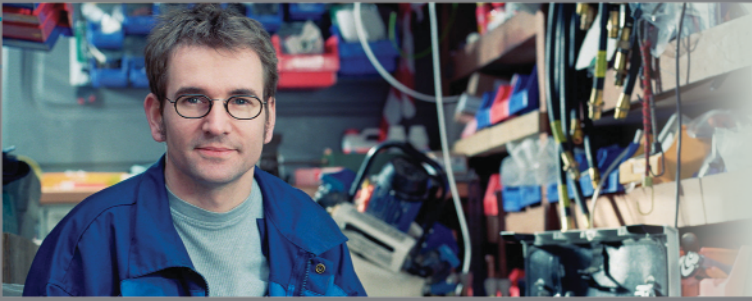

D-Link continues to lead the market in solutions for service providers meeting customer demand for broadband at home, at work and on the go.

D-Link Broadband Products



Broadband Modems

D-Link modems are standards-based connectivity devices that deliver strong, high-speed Internet connectivity.



Broadband Routers

D-Link's strength in engineering brings customizable router solutions to the service provider selling to the end-user consumer.



Voice & IP Communications

D-Link VoIP products are primarily sold through VoIP service providers, bringing affordable calling options over an Internet connection.



Wireless Media Players

D-Link media players and set-top boxes are next-generation, value-add devices for the service providers selling to the home consumer.



ADSL Modems

D-Link ADSL modems let you access a high-speed DSL Internet connection and offer Ethernet and USB ports for flexible connectivity.



Internet Cameras

D-Link SecuriCam Internet cameras represent another value-add option for service providers to bring access to live video streams over the Internet to the home consumer.



Switching

D-Link business-class Ethernet switching products are robust solutions capable of providing worldwide service provider networks.

Worldwide Service Provider Routers & Switches Manufacturer Revenue Forecast

Source: Infonetics Research

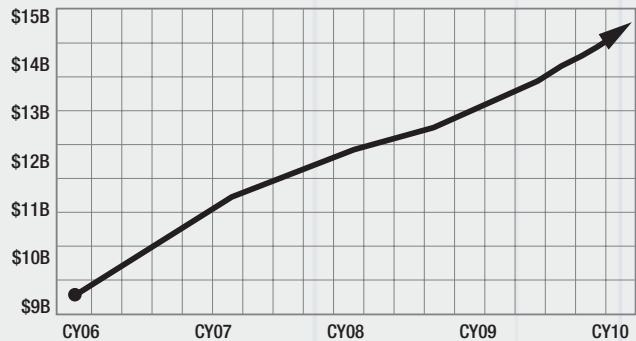

The worldwide carrier switch and router market hit 3.1 Billion (USD) in third quarter 2007.

Case Study – GoLiSka IT

GoLiSka IT consists of three community regional networks and is managed by a central IT unit for better service level. Town buildings, community departments, schools and libraries are connected to the regional network located in the west of Sweden.

The company wanted a centrally controlled infrastructure to give reliable and high-speed access to the three community networks. Central security policies and wireless control would be handled by the IT unit at the main data center. The core chassis were old Extreme switches, and the customer wanted to upgrade to the new D-Link DES-8010.

Solution: D-Link DES-3500 and DES-3800 used as access switches linked through a fiber network to DGS-3324SR switches stacked as aggregation and core switches in the main data center. Unified wireless switch solution (DWS-3024 and DWL-3500AP) serves the network with wireless access, centrally managed by the DWS-3024.

Product Design & Distribution

D-Link has largely contributed to what the world perceives networking to be, both in business and in the home. It is sometimes easy to overlook how quickly the Internet and computer networking have changed the way we do business and how we communicate.

For over 21 years, D-Link has taken the initiative in providing this technology, and making it accessible to businesses of any size, as well as consumers all over the world.

All along this journey, D-Link engineers have been the innovators. Founder Ken Kao once said, "D-Link's core competency is in Ethernet networking, and the Company drives innovation and development by producing a wide range of powerful, high-end wired and wireless networking solutions for home and businesses at the enterprise, workgroup, and departmental processing levels."

This means that D-Link does more than sell competing products to those of other enterprise-class switch manufacturers: the Company continues to pioneer the industry. D-Link's xStack line, for example, includes world-class, fully-managed switches available at a fraction of the cost of its competitors, backed by D-Link's renowned reliability. D-Link engineers apply the same innovative drive to business-class WLAN, storage and security products for medium and large enterprise.

D-Link's consumer products are known all over the world. Industry leading design and functionality, again supported by D-Link reliability, both create and serve a growing demand for networking at home and in the small office. With a foundation built upon the best-reviewed Wireless N routers in the industry, the digital home includes innovative network storage, Internet cameras, media players and IP telephony.

From fully-managed switches for enterprises to award-winning 802.11n routers for the home and SOHO, D-Link fuels and fills a global demand to work, communicate and recreate, by taking full advantage of the benefits of broadband. And because D-Link owns most of its supply chain, its products are feature-rich and competitively priced.

Producing goods for a global marketplace, D-Link expands each year to establish an ever-increasing number of localized business units. Being operated as a global brand, customers view D-Link products as being promoted and distributed by people they know, whether they are in South Africa, Brazil, the Czech Republic, or any of the 127 offices around the world.

This means that there is coordinated teamwork to produce cutting-edge products distributed to every corner of the world. Local teams communicate their local needs that D-Link headquarters fills from its own state-of-the-art manufacturing facilities within timeframes that its competitors cannot match.

D-Link's motto is "Building Networks for People." It is a way of doing business that is proven one customer at a time.



Producing goods for a global marketplace, D-Link expands each year to establish an ever-increasing number of localized business units.

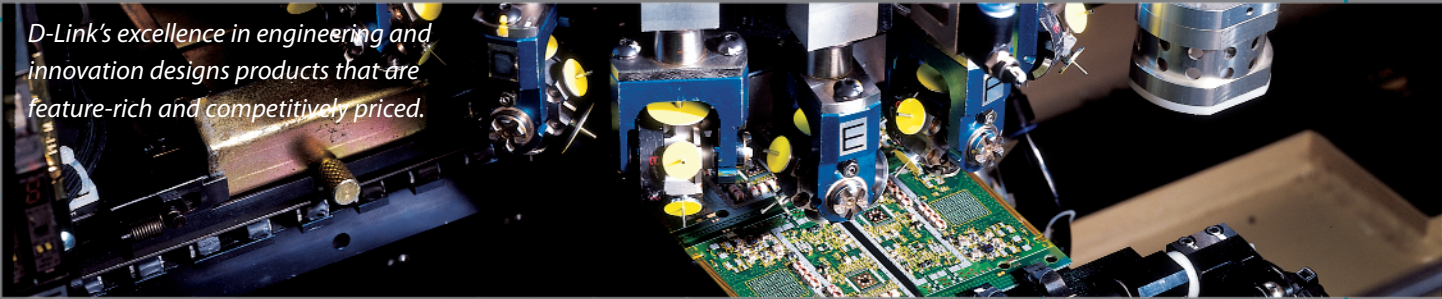

D-Link's excellence in engineering and innovation designs products that are feature-rich and competitively priced.



D-Link's vast worldwide resources include major manufacturing and distribution facilities worldwide, making the Company unique in the networking and connectivity industry. Pictured is D-Link's state-of-the-art manufacturing plant in Goa, India.



D-Link has built an extensive network of distribution and delivery channels that brings products to over 100 countries everyday.



D-Link realizes its global commitment with an aggressive delivery network. D-Link's ownership and influence of its supply chain is able to respond to market demand faster and more effectively than competitors.

Corporate Headquarters

No. 289, Sinhu 3rd Rd.,
Neihu District, Taipei City 114,
Taiwan
Tel: 886-2-6600-0123
Fax: 886-2-6600-9898

Independent Auditor

KPMG Certified Public Accountants

68F, Taipei 101 Tower, No. 7, Sec. 5,
Xinyi Road, Taipei, Taiwan
Tel: 886-2-8101-6666
Fax: 886-2-8101-6667

Transfer Agent

China Trust Commercial Bank

6F., 83, Chung-Ching South Road
Sec.1
Taipei
Taiwan
Tel: 886-2-2361-3033
Fax: 886-2-2311-6723

Investor Relations

No. 289, Sinhu 3rd Rd.,
Neihu District, Taipei City 114,
Taiwan
Tel: 886-2-6600-0123
Fax: 886-2-8791-4796
URL: ir.dlink.com.

Board of Directors

John Lee

Chairman, Director

A.P. Chen

CFO, Director

Hua-Lung Hsing

Director

Charley Chang

Director

Kenneth Tai

Director

Mason Liu

Director

Edward Shin

Director

Hui-Ci Hu

Supervisor

Joan Chen

Supervisor

International Offices

U.S.A

17595 Mt. Herrmann Street
Fountain Valley, CA 92708, USA
TEL: (714)885-6000
URL: www.dlink.com

Canada

2180 Winston Park Drive
Oakville, Ontario, L6H 5W1
Canada
TEL: +1-905-8295033
FAX: +1-905-8295223
URL: www.dlink.ca

D-Link European HQ and UK&I Operation

D-Link House, 1 Abbey Road
Park Royal, London, NW10 7BX,
UK
TEL: +44-20-8955-9000
FAX: +44-20-8955-9002
URL: www.dlink.co.uk

Austria

Millennium Tower
Handelskai 94-96, A-1200 Wien
Austria
TEL: +43 1 240 27270
FAX: +43 1 204 27271
URL: www.dlink.at

Germany

Schwalbacher Strasse 74
D-65760 Eschborn, Germany
TEL: +49-6196-77990
FAX: +49-6196-7799300
URL: www.dlink.de

France

41 Boulevard Vauban
78280 Guyancourt, France
TEL: +33 1 30 23 86 88
FAX: +33 1 30 23 86 89
URL: www.dlink.fr

Netherlands

Weena 290, 3012 NJ
Rotterdam, Netherlands
TEL: +31-10-282-1445
FAX: +31-10-282-1331
URL: www.dlink.nl

Belgium & Luxemburg

Rue des Colonies 11
B-1000 Brussels, Belgium
TEL: +32(0)2 517 7111
FAX: +32(0)2 517 6500
URL: www.dlink.be

Bulgaria

60A Bulgaria Blvd., Office 1
Sofia 1680, Bulgaria
TEL: +3592 958 2242
FAX: +3592 958 6557
URL: www.dlink.eu

International Offices (Continued)

Switzerland

Glatt Tower, 2. OG CH-8301
Glattzentrum Postfach 2. OG
Switzerland
TEL: +41 (0) 1 832 11 00
FAX: +41 (0) 1 832 11 01
URL: www.dlink.ch

Sweden

Gustavslundsvagen 151B
S-167 15 Bromma, Sweden
TEL: +46-(0)8564-61900
FAX: +46-(0)8564-61901
URL: www.dlink.se

Denmark

Naverland 2, DK-2600
Glostrup, Copenhagen
Denmark
TEL: +45-43-969040
FAX: +45-43-424347
URL: www.dlink.dk

Norway

Karihaugveien 89
N-1086 Oslo, Norway
TEL: +47 99 300 100
FAX: +47 22 30 95 80
URL: www.dlink.no

South Africa

Einstein Park II, Block B
102-106 Witch-Hazel Avenue
First Floor Block B, Einstein Park II
Highveld Techno Park
Centurion, Gauteng
Republic of South Africa
TEL: +27-12-665-2165
FAX: +27-12-665-2186
URL: www.d-link.co.za

Russia

Grafsky per., 14, floor 3
Moscow, 129626 Russia
TEL: +7-495-744-0099
FAX: +7-495-744-0099
URL: www.dlink.ru

Japan

Konan YK Building 6 F
Konan 2-4-12, Minato-ku
Tokyo 108-0075, Japan
TEL: +81-3-5781-0963
FAX: +81-3-5781-0965
URL: www.dlink-jp.com

Korea

Rm 306 Samsung IT Valley,
197-5, Guro-Dong, Guro-Gu
Seoul, Korea - Zip Code 150-050
TEL: +82-2-2028-1810
FAX: +82-2-2028-1829
URL: www.d-link.co.kr

China

Room02-05, Floor 26, Building B,
Global trade center, 36 north third
ring road east, Dongcheng District,
Beijing 100013, China
TEL: +86-10-58257789
FAX: +86-10-58257792
URL: www.dlink.com.cn

Taiwan

No. 289 Xinhua 3rd Road
Neihu, Taipei 114, Taiwan
TEL: +886-2-6600-0123
FAX: +886-2-6600-3939
URL: www.dlinktw.com.tw

Headquarters

No. 289 Xinhua 3rd Road
Neihu, Taipei 114, Taiwan
TEL: +886-2-6600-0123
FAX: +886-2-6600-9898
URL: www.dlink.com.tw

Finland

Latokartanontie 7A
FIN-00700 Helsinki, Finland
TEL: +358-10 309 8840
FAX: +358-10 309 8841
URL: www.dlink.fi

Italy

Via Nino Bonnet n. 6/b
20154 Milano, Italy
TEL: +39-02-2900-0676
FAX: +39-02-2900-1723
URL: www.dlink.it

Spain

Avenida Diagonal, 593-595
9 floor, 08014 Barcelona, Spain
TEL: +34 93 409 0770
FAX: +34 93 491 0795
URL: www.dlink.es

Portugal

Rua Fernando Pahlha, 50 Edificio
Simol, 1900 Lisbon Portugal
TEL: +351 21 8688493
FAX: +351 21 8622492
URL: www.dlink.pt

Romania

Blv Unirii No. 55, bl. E4A,
Sc.2, Et.4, Ap.39, sector 3,
Bucharest, Romania
TEL: +40(0)21 3202305
FAX: +40(0)21 3202307
URL: www.dlink.ro

Greece

101, Panagoulis Str., 163-43
Helioupolis Athens, Greece
TEL: +30 210 9914512
FAX: +30 210 9916902
URL: www.dlink.gr

Czech Republic

Vaclavske namesti 36
Praha 1, 110 00
Czech Republic
TEL: +420 224 247 500
FAX: +420 224 234 697
URL: www.dlink.cz

Hungary

Rakoczi ut 70-72,
HU-1074 Budapest, Hungary
TEL: +36 (0) 1 461 30 00
FAX: +36 (0) 1 461 30 04
URL: www.dlink.hu

Poland

Budynek Aurum ul. Walicow 11
PL-00-851 Warszawa, Poland
TEL: +48 (0) 22 583 92 75
FAX: +48 (0) 22 583 92 76
URL: www.dlink.pl

Singapore

1 International Business Park
#03-12 The Synergy
Singapore 609917
TEL: +65-6774-6233
FAX: +65-6774-6322
URL: www.dlink-intl.com

Australia

Building A, Level 3, 11 Talavera
Road, North Ryde, NSW 2113,
Australia
TEL: +61-2-8899-1800
FAX: +61-2-8899-1868
URL: www.dlink.com.au

India

D-Link House, Plot No. 5
Kurla-Bandra, Complex Road
Off. CST Road, Santacruz (E)
Mumbai 400 098, India
TEL: +91-22-2652 6696
FAX: +91-22-2652 8914
URL: www.dlink.co.in

Middle East (Dubai)

P.O. Box 500367, 103 Building 3
Dubai Internet City, Dubai
United Arab Emirates
TEL: +971-4-391-6480
FAX: +971-4-390-8881
URL: www.dlink-me.com

Egypt

47 El Merghany Street
Heliopolis, Cairo, Egypt
TEL: +202-291-9035
+202-291-9047 Ext. 104-109
FAX: +202-291-9051
URL: www.dlink-me.com

Turkey

Armada Bilgisayar Sist. San.
Ve Tic. AS, Maltepe Caddesi
No: 10/B Bayrampasa
Istanbul, Turkey
TEL: 0212-289-5659
FAX: 0212-289-7606
URL: www.dlink.com.tr

Iran

Unit 9, 5th Floor No. 16, 35th alley,
Alvand St. Argentina SQ,
Tehran, Iran
TEL: +98-21-8888-0918,19
FAX: +98-21-8888-0918,19
URL: info.ir@dlink-me.com

Pakistan

311 Business Avenue
Main Shahrah-e-Faisal, Karachi
Pakistan
TEL: +92-21-454-8158
+92-21-454-8310
FAX: +92-21-453-5103
URL: www.dlink-me.com

Israel

20 Ha-Magshimim str,
Kiryat Matalon, Petach Tikva,
49348, Israel
TEL: +972-3-9215173
FAX: +972-3-9219005
URL: www.dlink.co.il

Latin America

Avenue Vitacura 2939, Piso 6
Edificio Millenium,
Las Condes, Santiago, Chile
TEL: +56-2-5838-950
+56-2-5838-951
FAX: +56-2-5838953
URL: www.dlinkla.com

Brazil

Praca General Gentil Falcao,
108-Cj 11/12
Sao Paulo - SP - Brasil
CEP: 04571-150
TEL: +55-11-2185-9300
FAX: +55-11-2185-9322
URL: www.dlinkla.com

Mexico

D-Link Mexicana S.A. de C.V.
Blvd. Avila Camacho #40, piso 18
Col. Lomas de Chapultepec
Mexico, D.F. 11000
URL: www.dlinkla.com